

LDLS SERIES RESIDENTIAL LIGHTING

LDLS-6-MCT5
MINI LINEAR OPTIC-LIGHT FIXTURES, SNAP IN 5CCT
MCT5 Multi Color Temperature (Selectable)

Customer Name: _____
Project Name: _____
Note: _____ | Type: _____

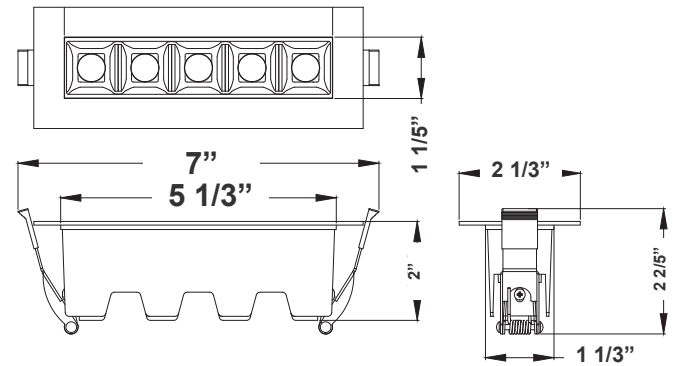
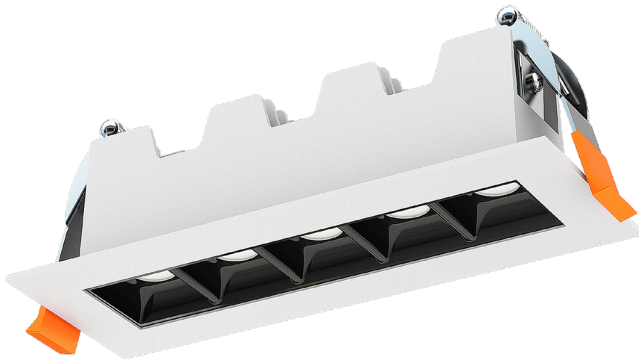

2"(H) X 7"(W) X 1 1/5"(D)

Discover the High End Mini 5 head LED Linear Downlight: a pinnacle of modern lighting innovation. Engineered with an external driver housed in a convenient junction box, this fixture harmonizes classic aesthetics with unparalleled performance and adaptability. Tailored to meet diverse demands and applications, it stands as an epitome of elegance, functionality, and flexibility in lighting solutions.

Features

- LED Architectural Recessed Trim
- Die-Cast Aluminum Heat Sink
- 5-Year Warranty
- Junction Box Included With Fixture

Technical Specifications

Electrical:

- Voltage: 120VAC
- Wattage: 11W
- Power Factor: >0.90
- Efficacy: Up to 54 LM/W

Mechanical:

- Up to 9 AWG18 Wires
- Die-cast Aluminum With white Powder Coat Finish
- Clear Glass Lens
- Junction Box Included, Install Directly In Insulated Ceilings (IC) Without Any Thermal Housing
- Type IC Rated: Approved for Direct Contact With Insulation
- Operating Temperature: 104°F
- Air-Tight and Type IC Rated: No housing Required
- Damp Location Only
- 5-Year Warranty

Lighting:

- Multi CCT (Selectable Switch On the Back Of The Driver)
- Dimming: Dimmable Down to 10% Using Standard TRIAC LED Dimmer
- Total Lumens: 600LM
- Color Temperature: 2700K/3000K/3500K/4000K/5000K
- Color Rendering index: >90
- Beam Angle: 15° / 30° / 45°
- Lifespan: 50,000 Hrs.

Applications:

- Ideal for New as well as old residential and commercial constructions.

Other Models:

- 18W | 1200LM | LDLS-12-MCT5



Photometrics: LDLS-6-MCT5

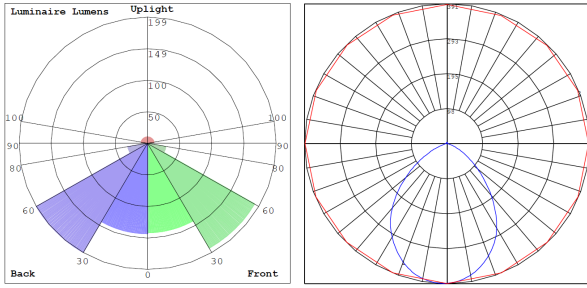

BUG Rating: B1-U2-G0

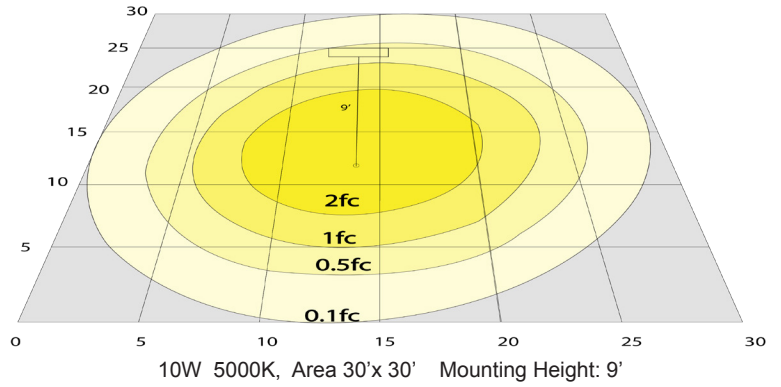

Other Views:

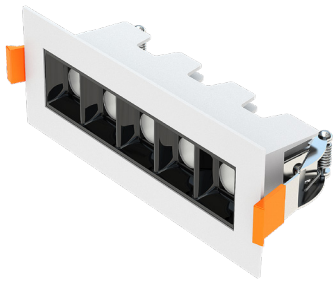

Side View

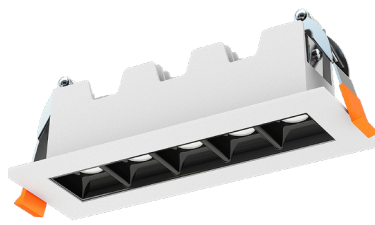

Bottom View

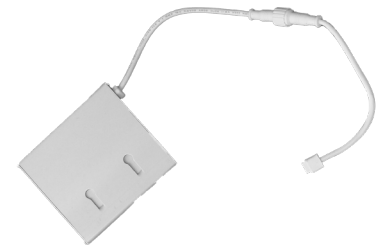

Junction box 1-1/4" thick included with fixtures

Performance Table: LDLS-6-MCT5

MODEL NO.	Wattage	Voltage	Lumens	Color Temp.	BUG Rating	LPW
LDLS-6-MCT5	11W	120V	600LM	2700K	B1-U2-G0	54
				3000K		
				3500K		
				4000K		
				5000K		

Sample Ordering

Model **Size** **Color Temp.**
 - -

